

JOBS

RENAULT  Team *Supplier*



JOBS
HIGH PERFORMANCE MACHINING CULTURE

coesia GROUP



Headquarters





Assembly

Total floor area
60.000 m²
Production area
15.000 m²

MANUFACTURING SITE

The Group

<i>Key Figures</i>		
		
Sales	650 mil.€	31 mil. €
Employees	3200	185
Operating Units	30	4

COESIA GROUP

The Company

Jobs S.p.A. designs, manufactures and markets

- 5-axis high speed milling machines
- for machining of medium/large sized work pieces
- with complex shapes and profiles

THE COMPANY

Fields of Application

- Car design and prototyping
- Mould & dies
- Aeronautic industry
- General engineering

**FIELDS OF
APPLICATION**



JOBS
HIGH PERFORMANCE MACHINING CULTURE

coesia GROUP

SALES

BY GEOGRAPHIC AREA

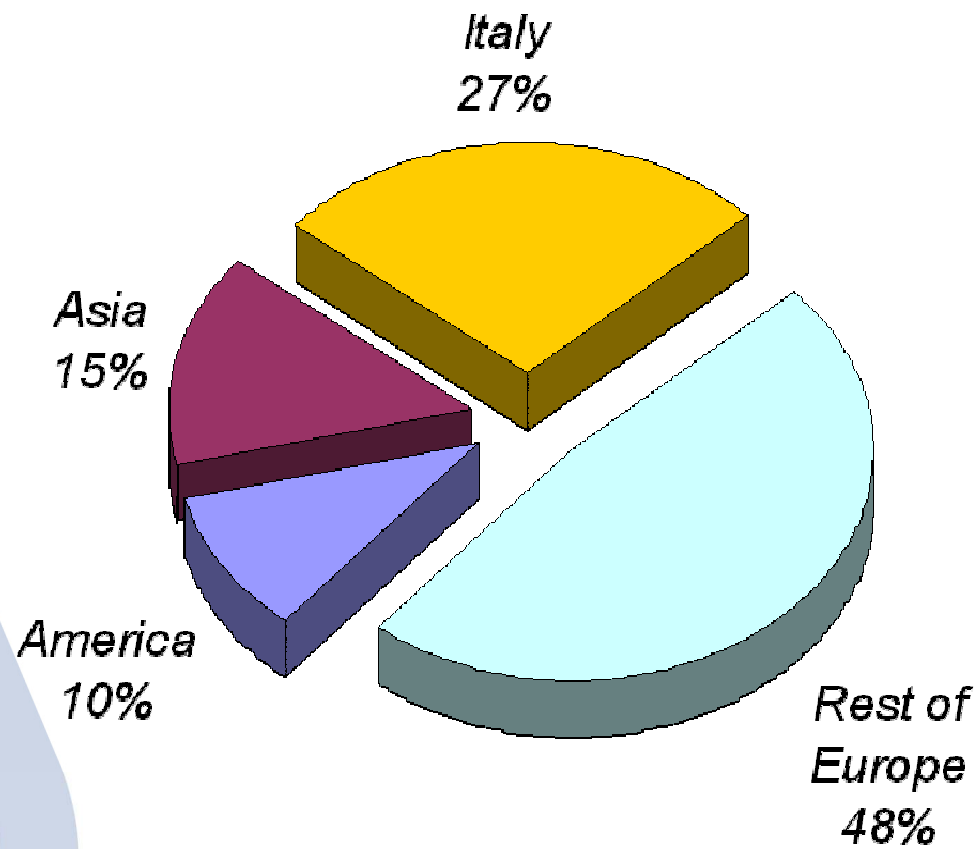

SALES FROM 2001

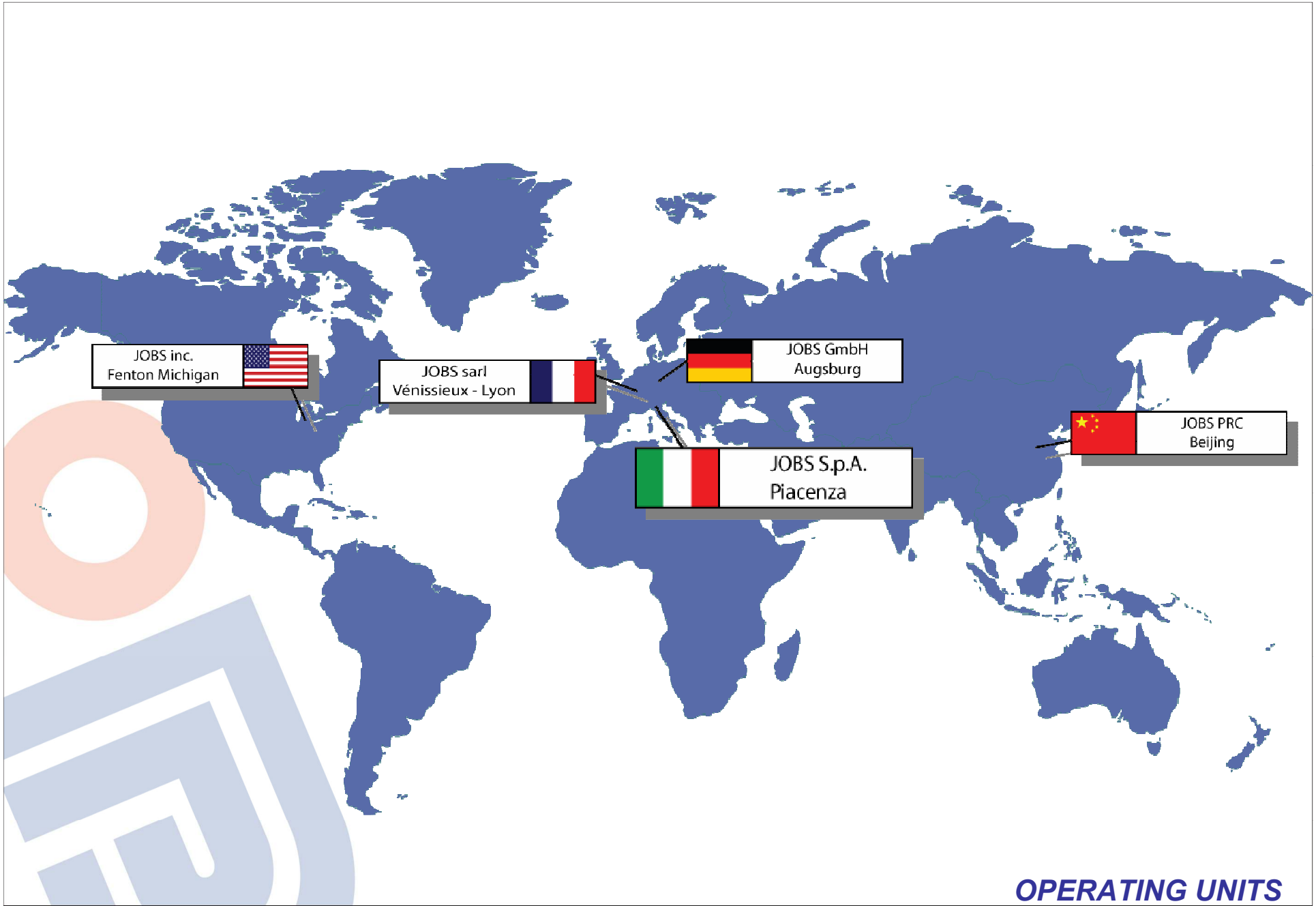

OPERATING UNITS

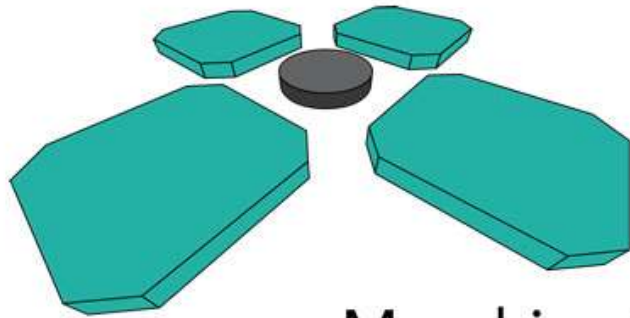

MUSP

Macchine Utensili e Sistemi di Produzione

*Jobs is a co-founder of MUSP: Research Lab for the
Study of Machine Tools and Production Systems,
Piacenza, Italy*

MUSP

JOBS

HIGH PERFORMANCE MACHINING CULTURE

coesia^{GROUP}

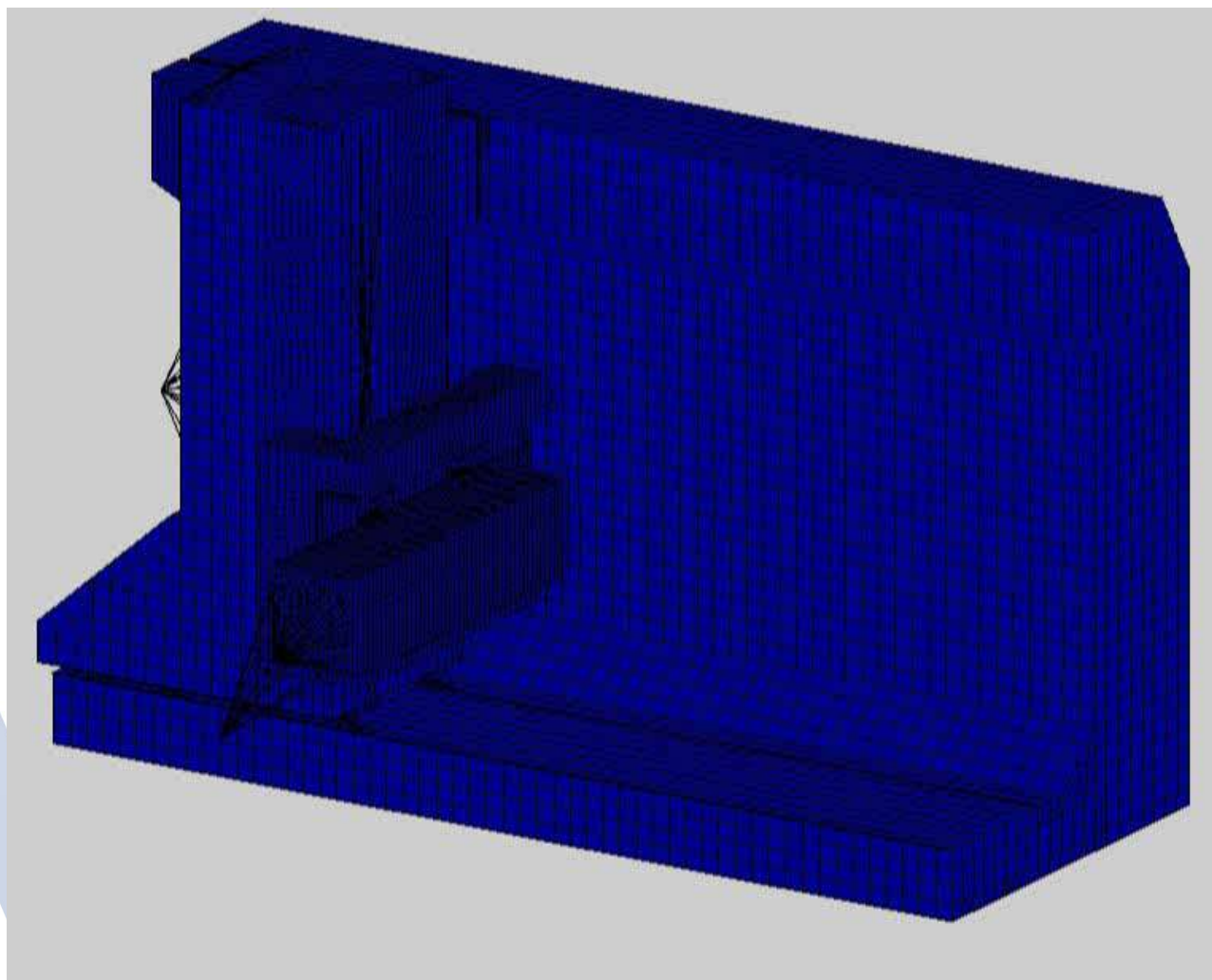

PART PROGRAM SIMULATION

VIRTUAL PROTOTYPING

Thermal analysis:

- Thermal profiles for components, milling heads, machine parts
- Cooling optimization
- Thermal compensation

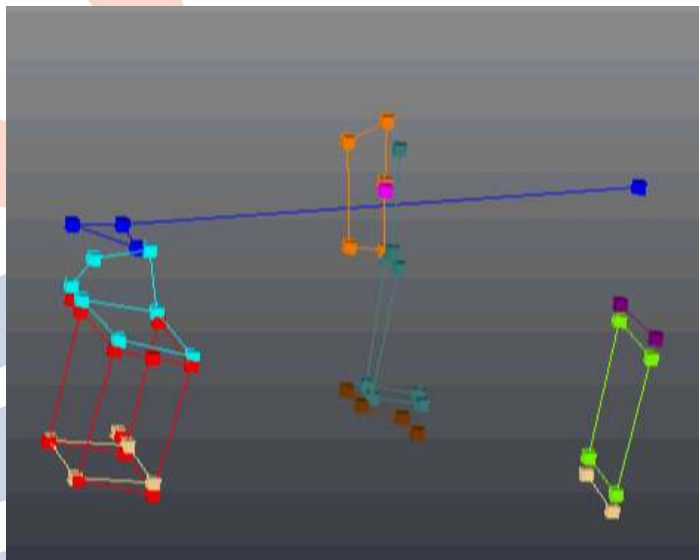
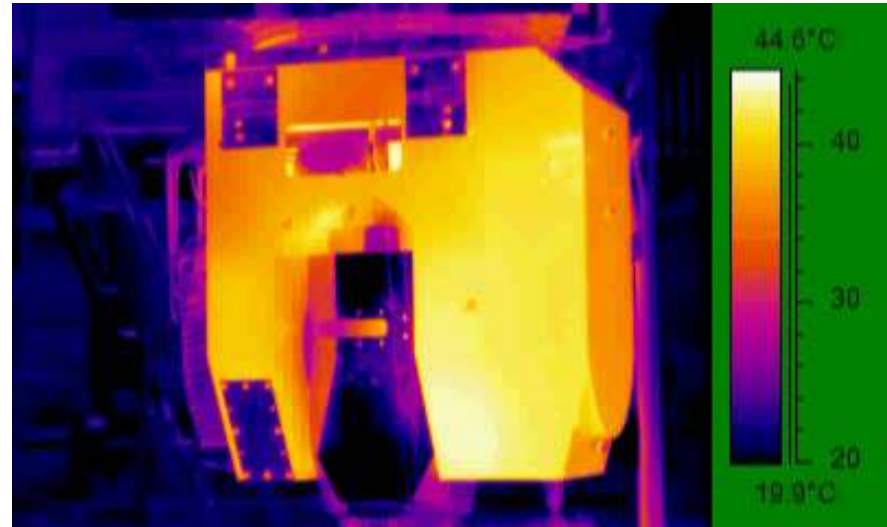

Experimental modal analysis:

- Frequency response
- Mode Shapes (for structural design optimization)
- Control System tuning

EXPERIMENTAL TESTING



AGUSTA



Alenia



BAE SYSTEMS



BMW Group
DesignworksUSA



DASSAULT
AVIATION



GIUGIARO



HONDA



GRUPO
Industria de Turbina Propulsoras, S.A.



McLaren

PSA PEUGEOT CITROËN

RAIL COACH FACTORY



RENAULT **FI** Team



SIEMENS

sneema



Sonaca

F1
Honda Racing
Team



ThyssenKrupp

VOLVO AERO



WILLIAMS **FI**

JOBS
HIGH PERFORMANCE MACHINING CULTURE

coesia GROUP